



“myReference,”

RIGID 30

LOCK

**Gerflor**<sup>®</sup>  
theflooringroup



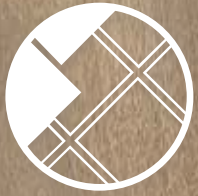
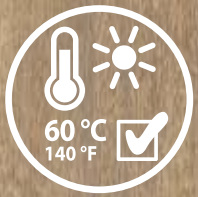
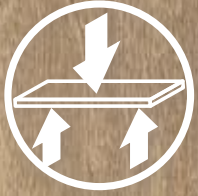

**RIGID 30**  
**LOCK**

178 x 1219 mm

228 x 1492 mm

457 x 914 mm

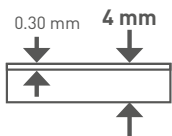

**PUR+ MATT**

Easy maintenance

**4D DESIGN**

**MATT SURFACE**

Natural look

**CRISTAL WEAR LAYER**

High definition design & color

**STRUCTURED EMOSS & BEVEL**

Ultra realistic surface

**XL FORMAT**

Wide variety of tiles & planks

**FULL RIGID CORE TECHNOLOGY**

Rigid

---

60 °C  
140 °F  
Max.

---

The best stability

---

Renovation ceramic  
6 mm joint

**LOCK SYSTEM**

Standard laminate installation



<b>RIGID</b>	<b>30</b>
	<b>LOCK</b>

178 x 1219 mm





228 x 1492 mm



457 x 914 mm



XL  
PLANKS

PUNO PURE

PUNO BROWN

KILDA GOLDEN

KILDA PEARL

XL  
TILES

TRONDHEIM

BELLO





KILDA PEARL



KILDA PEARL - 0019

228 x 1492 mm





KILDA GOLDEN - 0015

228 x 1492 mm



KILDA GOLDEN



PUNO PURE - 0017

228 x 1492 mm



PUNO PURE





PUNO BROWN



PUNO BROWN - 0016

228 x 1492 mm



TRONDHEIM - 0011

457 x 914 mm

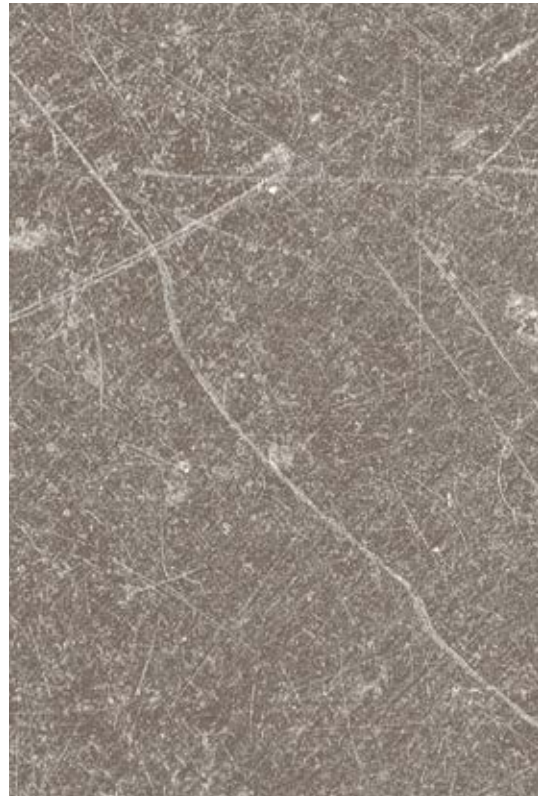

BELLO - 0013

457 x 914 mm



BELLO





TRONDHEIM

RIGID 30 LOCK  
CLASSIC WOOD



PUERTO - 0001

178 x 1219 mm



CRUNCHY - 0979

178 x 1219 mm



VIAJO - 0003

178 x 1219 mm



SUCRE - 0004

178 x 1219 mm



HOBART - 0002

178 x 1219 mm





HOBART



SUCRE



CRUNCHY



PUERTO



VIAJO

**RIGID 30 LOCK**  
**RUSTIC WOOD PLANK**



QUITO - 0007

178 x 1219 mm



LOVINA - 0008

178 x 1219 mm



CARTAGO - 0010

178 x 1219 mm



VIAJO GREY - 0009

178 x 1219 mm



SUAVE GREY - 0977

178 x 1219 mm





QUITO

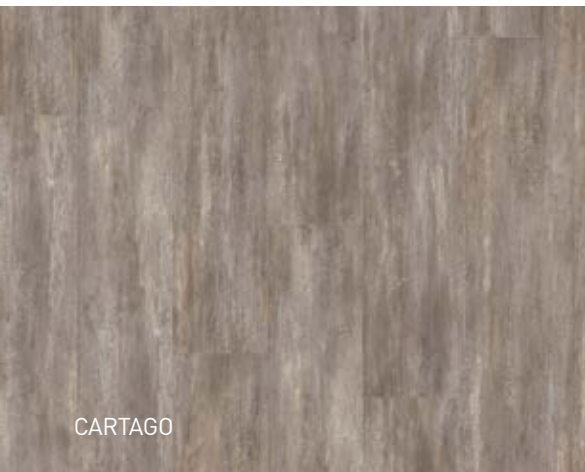

CARTAGO



SUAVE GREY



LOVINA



VIAJO GREY

# RIGID 30 LOCK

## A FULL SET OF FINISHES

### DESIGN SKIRTINGS

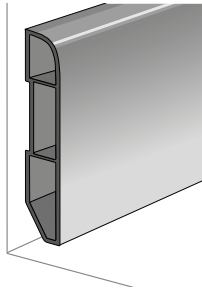
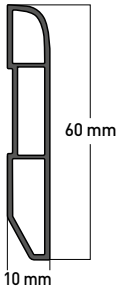

Vinyl design skirting  
Ref. 6086

- Up to 80sqm room only

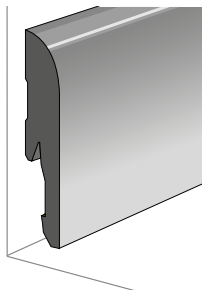
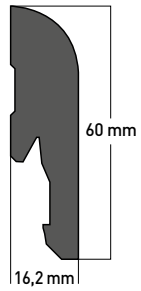

MDF design skirting  
Ref. 5947



ALL COLOURS AVAILABLE

Also available in white  
can be painted over

### OTHER SKIRTINGS

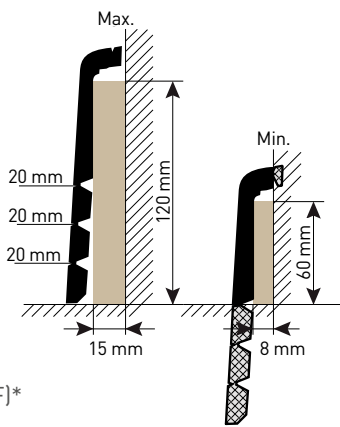

Cover skirting (MDF)\*  
Ref. 2550

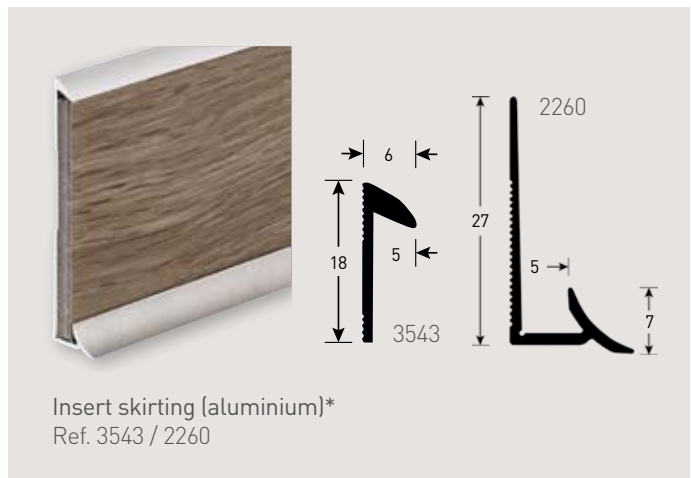

Insert skirting (aluminium)\*  
Ref. 3543 / 2260

### STAIRNOSING SOLUTION

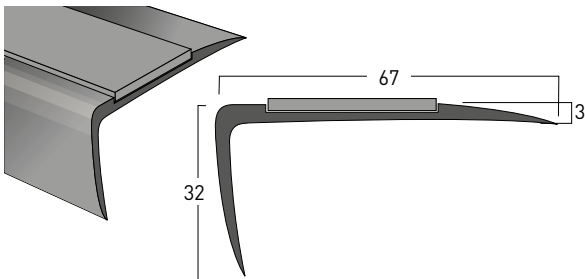

Nosing T67 (aluminium)  
Ref. 0503

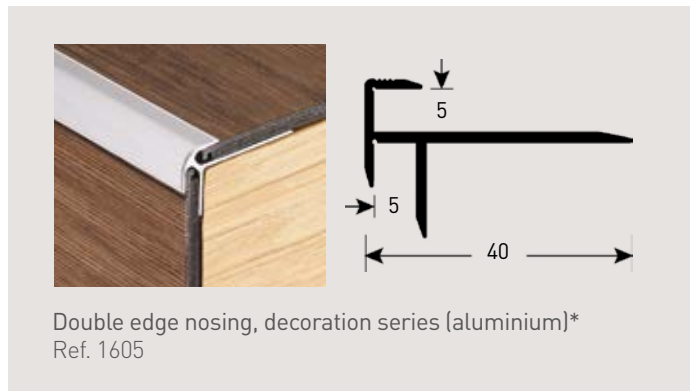

Double edge nosing, decoration series (aluminium)\*  
Ref. 1605



## I PROFILES

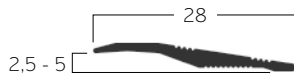
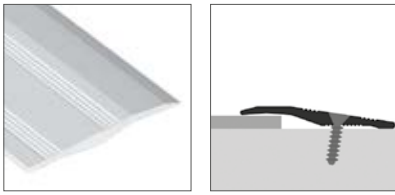

Ramp 2,5-5mm (aluminium)  
Ref. 2655



## I ENTRANCE MATS



Looselay Romat GT insert kit  
Ref. 1719

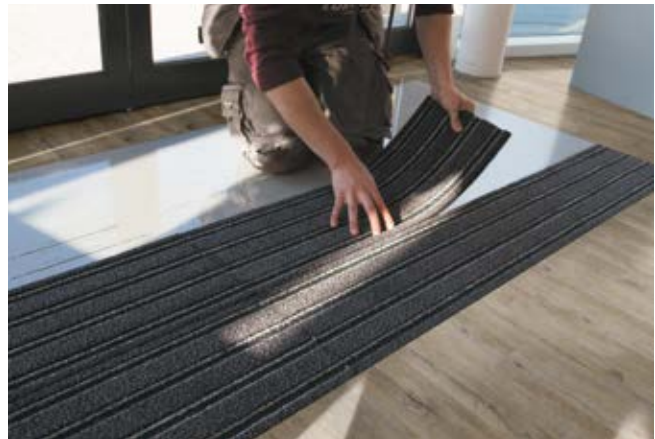

Quick mat\*  
Ref. 8550

## I FLOOR PROTECTION



Floor protection  
Ref. 058X

\*Please contact Romus [www.romusworld.com](http://www.romusworld.com) or Gradus [www.gradusworld.com](http://www.gradusworld.com).  
Romus and Gradus are part of Gerflor group.



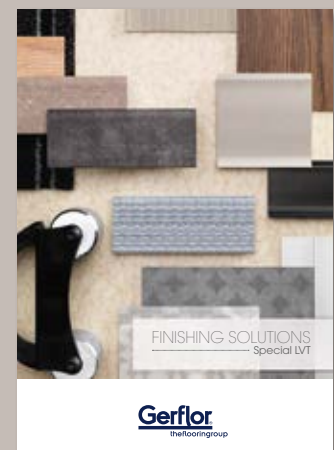









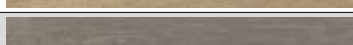

FOR MORE DETAILS  
visit [gerflor.com](http://gerflor.com)

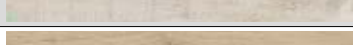

LVT finishes brochure

# RIGID 30 LOCK

## EQUIVALENCES RIGID 30 LOCK & CREATION 30

	RIGID 30 LOCK	CREATION 30 GLUE DOWN / CLIC
	CARTAGO - 0010	AMADOR - 0447
	HOBART - 0002	BALLERINA - 0347
	KILDA PEARL - 0019	SWISS OAK PEARL - 0846
	KILDA GOLDEN - 0015	SWISS OAK GOLDEN - 0796
	VIAJO - 0003	BOSTONIAN OAK - 0871
	VIAJO GREY - 0009	BOSTONIAN OAK GREY - 0855
	PUNO BROWN - 0016	CEDAR BROWN - 0850
	PUNO PURE - 0017	CEDAR PURE - 0849
	BELLO - 0013	CARMEL - 0618
	QUITO - 0007	ARENA - 0060
	SUCRE - 0004	TWIST - 0504
	TRONDHEIM - 0011	NORVEGIAN STONE - 0860
	LOVINA - 0008	RANCH - 0456
	PUERTO - 0001	QUARTET - 0503
	SUAVE GREY - 0977	OXFORD - 0061
	CRUNCHY - 0979	BUFFALO - 0457

### INSTALLATION



LOCK SYSTEM



CUTTING WITH A SAW

### UNDERLAYERS



 UNDERLAY  
GERFLOR ACOUSTIC / 15 dB



 UNDERLAY  
GERFLOR SILENCE PLUS / 19 dB

More details on [gerflor.com](http://gerflor.com)



DESCRIPTION / BESCHREIBUNG / BESCHRIJVING / DESCRIPTION / DESCRIPCIÓN / DESCRIÇÃO / DESCRIZIONE

Total Thickness / Gesamtdicke / Totale dikte / Épaisseur totale / Espesor total / Espessura total / Spessore totale	EN ISO 24346 [EN 428]	mm	4.00		
Thickness of the wearlayer / Dicke der Nutzschiicht / Dikte van de slijtlaag / Épaisseur couche d'usure / Espesor capa de uso / Espessura camada de desgaste / Spessore strato di usura	EN ISO 24340 [EN 429]	mm	0.30		
Weight / Flächengewicht / Gewicht / Poids / Peso / Peso / Peso	EN ISO 23997 [EN 430]	g/m <sup>2</sup>	7890		
Size / Format / Afmetingen / Format / Dimensiones / Dimensões / Dimensioe	ISO 24342 [EN 427]	mm	178x1219	228x1492	457x914
Number of planks / tiles and sqm per box	-	-	7 / 1.52 m <sup>2</sup>	5 / 1.70 m <sup>2</sup>	5 / 2.09 m <sup>2</sup>

CLASSIFICATION / KLASSIFIKATION / CLASSIFICATIE / CLASSIFICATION / CLASIFICACIONES / CLASSIFICAÇÕES / CLASSIFICAZIONI

Norm/Product Specification / Produktnorm / Technische eigenschappen / Norme/ Spécification produit / Normas / Normas / Norma prodotto	-	-	EN ISO 10582		
European Classification / Europäische Klassifizierung / Europese classificatie / Classement européen / Classificación europea / Classificação Europeia / Europea	EN ISO 10874 [EN 685]	Class	23 - 31		
Fire Rating / Brandverhalten / Brand classificatie / Classement Feu / Fuego / Fogo / Reazione al fuoco	EN 13 501-1	Class	Bfl-s1		
Static Electrical Propensity / Begehaufladung / Elektrische eigenschappen / Potentiel de charge / Comportamiento electrostático / Comportamento electrostático / Resistenza elettrica	EN 1815	kV	< 2		
Slip Resistance Wet / Rutschhemmung / Anti-slip / Glissance humide / Deslizamiento húmedo / Escorregamento húmido / Scivolosità umida	DIN 51130	Class	R10 <sup>(1)</sup>		





PERFORMANCES / TECHNISCHE EIGENSCHAFTEN / TESTRESULTAAT / PERFORMANCE / CUALIDADES TÉCNICAS / PERFORMANCES / CARATTERISTICHE TECNICHE

Wear Resistance / Verschleißverhalten / Slijtvastheid / Résistance à l'usure / Abrasión / Abrasão / Resistenza all'abrasione	EN 660.2	mm <sup>3</sup>	≤ 2.0		
Wear Group / Verschleißgruppe / Groep slijtvasheid / Groupe d'abrasion / Grupo de abrasión / Grupo de abrasão / Gruppo di abrasione	NF 189	group	T		
Type Binder content / Bindemittelgehalt / Teneur en agent liant / Contenido en ligante / Conteúdo em ligante	EN ISO 10582	type	I		
Room Impact / Raumschall / Loopgeluid / Sonorité à la marche / Rumore al calpestio / Sonoridad en la pisada / Sonoridade ao andar	NF S 31074	dB	80		
Impact sound insulation / Trittschallverbesserungsmaß / Geluidsisolatie / Isolation acoustique bruits de chocs / Acústica / Isolamento acústico	EN ISO 717-2	dB	4		
Dimensional Stability (norm) / Maßstabilität / Maatvastheid / Stabilité dimensionnelle / Estabilidad dimensional / Estabilidade dimensional / Stabilità dimensionale	EN ISO 23999 [EN 434]	%	≤ 0.15		
Dimensional Stability (average measured value) / Maßstabilität / Maatvastheid / Stabilité dimensionnelle / Estabilidad dimensional / Estabilidade dimensional / Stabilità dimensionale	-	-	≤ 0.08		
Residual Indentation / Resteindruck / Indrukbelasting / Poinçonnement statique rémanent / Punzonamiento / Punçoamento / Impronta	EN ISO 24343-1 [EN 433]	mm	≤ 0.10		
Castor chair test / Stuhlrollenbeanspruchung / Rolweerstand bureaustoelen / Essai de la chaise à roulettes / Determinación del efecto de una silla con ruedas / Resistência a cadeiras de rodas / Resistenza al passaggio di sed [Type W]	ISO 4918 [EN 425]	-	OK		
Thermal Conductivity / Wärmeleitfähigkeit / Thermische weerstand / Conductivité thermique / Conductividad térmica / Contutividade térmica / Resistenza termica / Värmeledningsmotstånd / Varmemotstånd	EN ISO 10456 [EN12524]	W/(m.K)	0.25		
Colour Fastness / Lichtechtheit / Lichtechtheid / Solidité lumière / Resistencia a la luz / Estabilidade das cores / Solidità alla luce	EN 20 105 - B02	degree	> 6		
Surface Treatment / Oberflächenvergütung / Oppervlaktebehandeling / Traitement de surface / Tratamiento de superficie / Tratamento de superficie / Trattamento di superficie	-	-	PUR+ Matt		
Chemical Products Resistance / Verhalten gegenüber Chemikalien / Chemische bestendigheid / Résistance aux produits chimiques / Resistencia a los productos químicos / Resistência aos produtos químicos / Resistenza ai prodotti chimici <sup>(2)</sup>	EN ISO 26987 [EN 423]	-	OK		

ENVIRONMENT/INDOOR AIR QUALITY / UMWELT/RAUMLUFTQUALITÄT / ENVIRONNEMENT/QUALITE DE L'AIR INTERIEUR /  
MEDIO AMBIENTE/CALIDAD INTERIOR DEL AIRE INTERIOR / MEIO AMBIENTE/QUALIDADE DO AR INTERIOR

TVOC after 28 days / TVOC (28 Tage) / TVOC (28 dagen) / TVOC après 28 jours / TVOC (28 dias) / TVOC (28 dias) / TVOC (28 giorni) / TVOC (28 dagar) / TVOC (28 dager)	ISO 16000-6	µg/m <sup>3</sup>	< 100		
---	-------------	-------------------	-------	--	--

CE MARKING / CE KENNZEICHNUNG / EG\_CONFORMITEITSMERK / MARQUAGE CE / MARCA DE CONFORMIDAD CE / MARCA DE CONFORMIDADE CE /  
MARCATURA CE DI CONFORMITA

	EN 14041	-				
---	----------	---	---	---	---	---

(1) Glissance humide / Slip resistance wet / Rutschhemmung : details sur site gerflor.com / details on website gerflor.com / Einzelheiten auf der web-site gerflor.com

(2) Beständig gegenüber nicht färbenden alkoholhaltigen Handdesinfektionsmitteln, Haushaltschemikalien und verdünnten Säuren und Laugen bei kurzzeitiger Einwirkung.

**Gerflor International**  
Tel: +33 (0)4 74 05 40 00  
Fax: +33 (0)4 74 05 03 13  
e-mail: gerflorcontract@gerflor.com

**ROMUS**  
ZA Les Pouards  
13 et 15, Rue Taillefer  
91160 Champlan  
France  
Tel : +33 (0) 1 69 79 69 77  
email: welcome@romusworld.com  
www.romusworld.com

**Visualize your reference**



[interiordesigner.gerflor.com](http://interiordesigner.gerflor.com)

**30 years experience**  
Since 1985

**Manufacturer**  
3 LVT Factories

**World Class Logistics**  
12 Logistics Hubs

**Gerflor Design Centre**  
Exclusive Designs

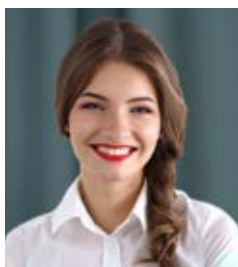

**“Serenity,,**  
Julia - **End User**



**“Time saving,,**  
Mika - **Installer**



**“Design,,**  
Pierre - **Architect**



**“Confidence,,**  
Claire - **Store Manager**



**“Flexibility,,**  
Hans - **Distributor**

That's why Gerflor is our **Reference**

**Gerflor**<sup>®</sup>  
theflooringgroup